

# SlimPanel

Mural / Wall

Doc. SLP.  
NdP. Mural.  
V1

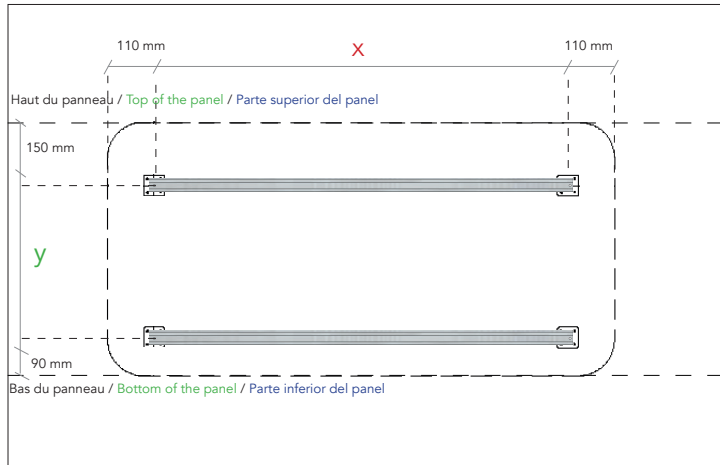
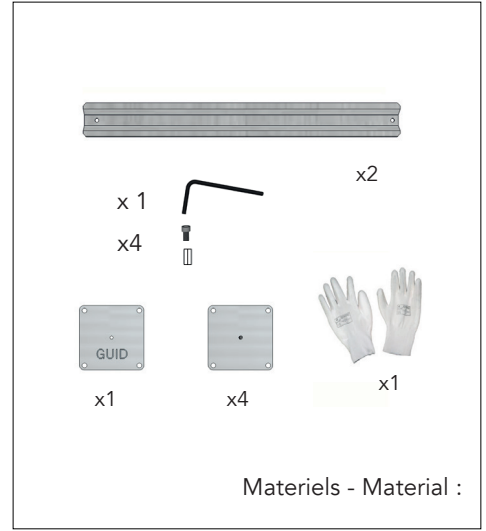
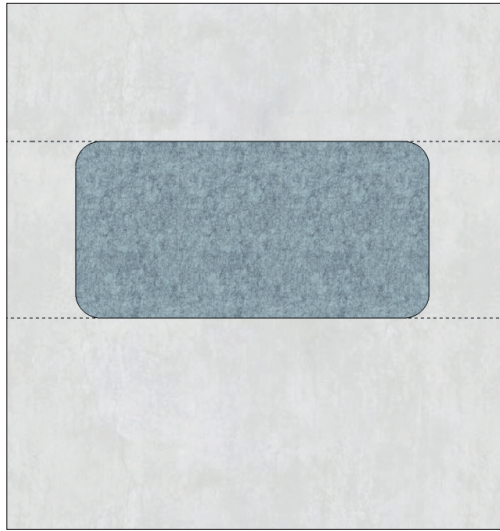
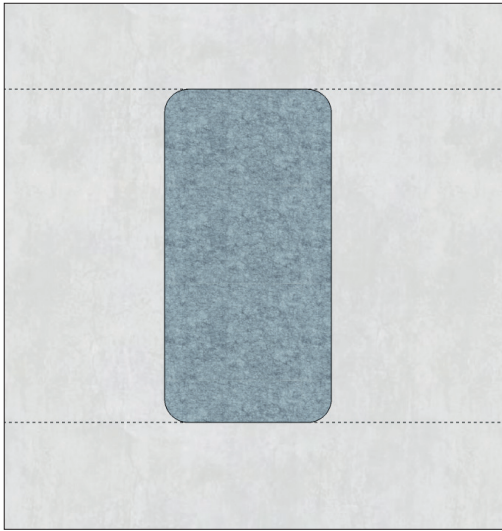

Pose Horizontale ( en mm )  
Horizontal Mounting ( in mm )  
Posición horizontal ( en mm )

	x	y
1200 x 600	980 mm	360 mm
1200 x 400	980 mm	160 mm
2400 x 1200	2180 mm	960 mm
2400 x 600	2180 mm	360 mm
2400 x 400	2180 mm	160 mm

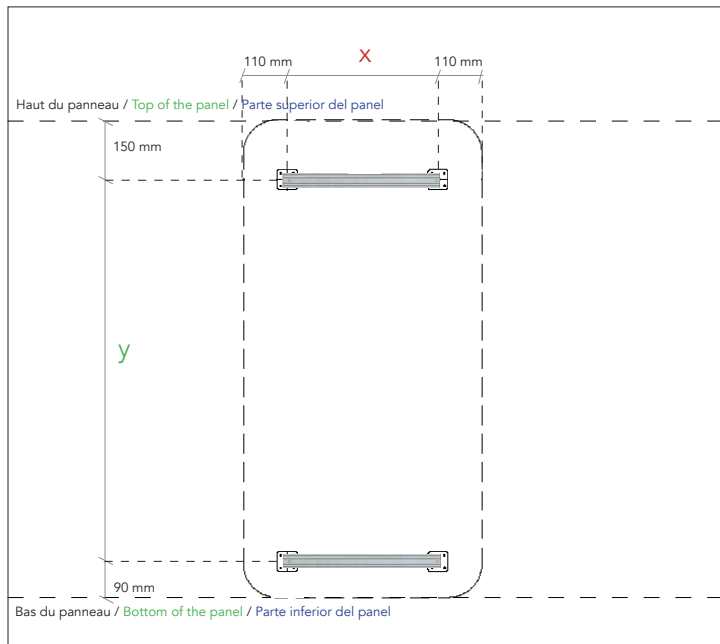

Pose Verticale ( en mm )  
Vertical Mounting ( in mm )  
Posición vertical ( en mm )

	x	y
1200 x 1200	980 mm	960 mm
1200 x 600	380 mm	960 mm
1200 x 400	180 mm	960 mm
2400 x 1200	980 mm	2160 mm
2400 x 600	380 mm	2160 mm
2400 x 400	180 mm	2160 mm

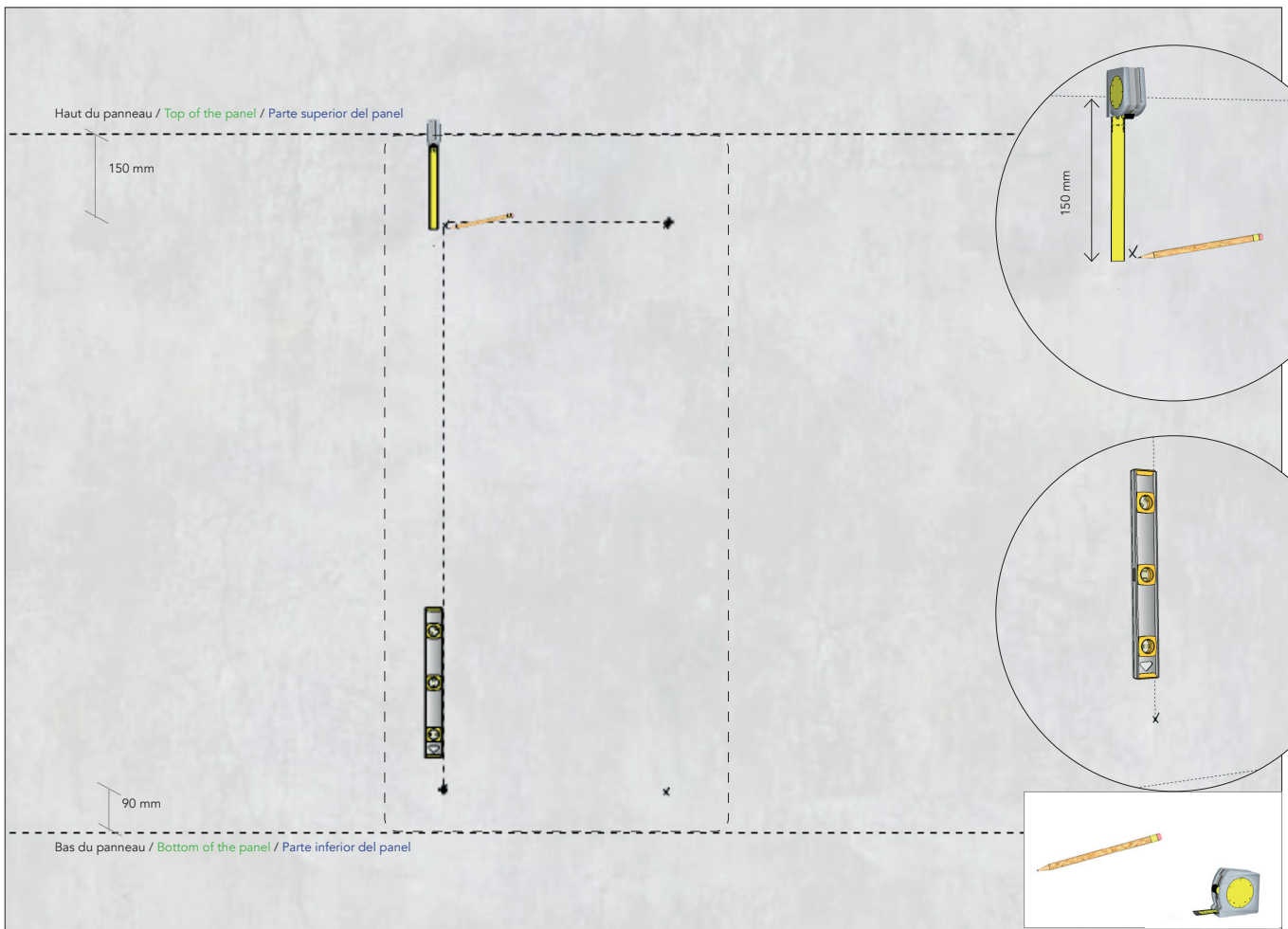

1. Définir l'emplacement du panneau final. Puis repérer les 4 patères, à l'aide du mètre, et du niveau, sur base du tableau au recto.

1. Define the position of the final panel. Then mark the 4 hooks.

1. Definir la ubicación final del panel. Marcar luego la ubicación de las 4 pletinas.

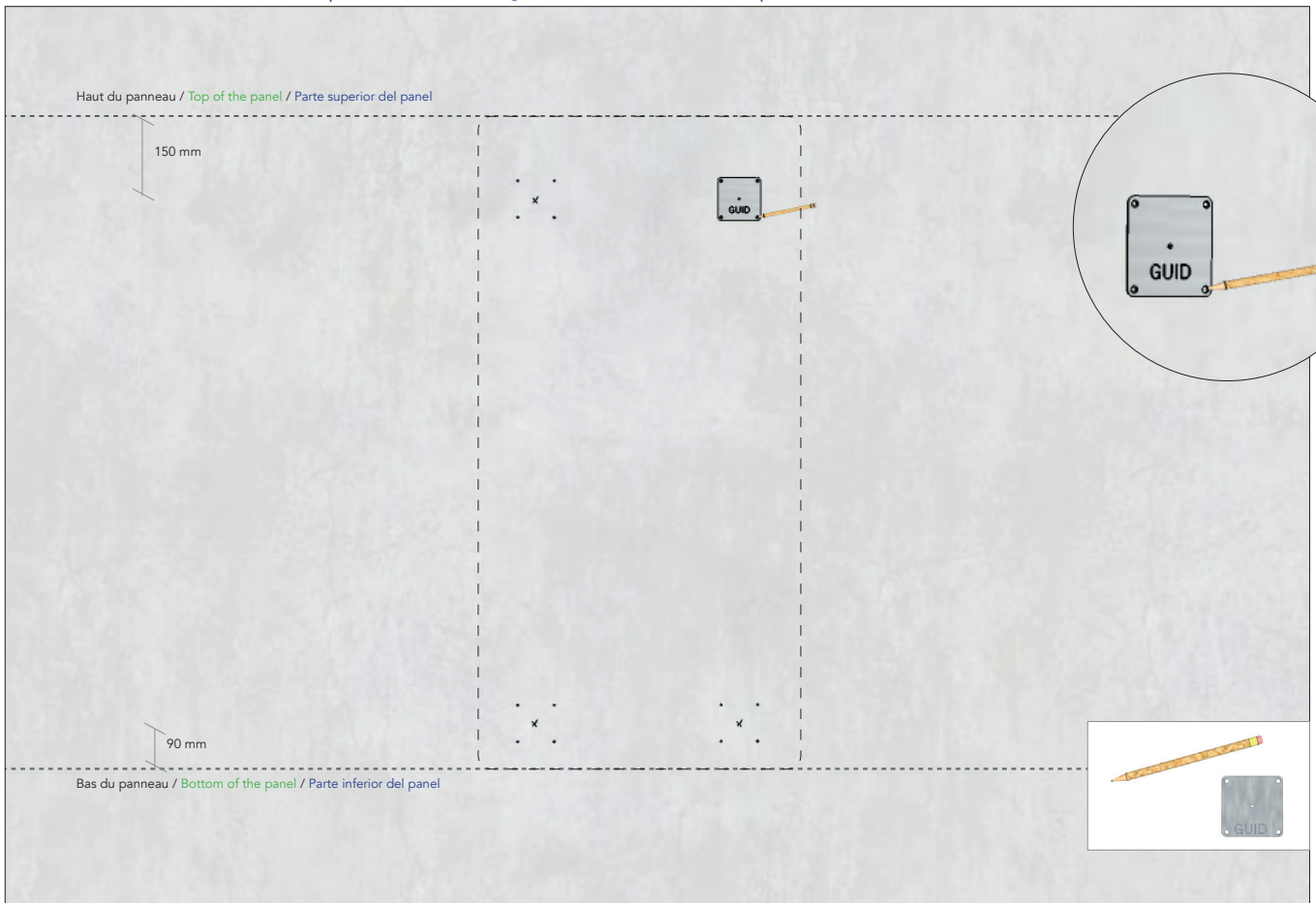

2. Marquer le placement des vis à l'aide du gabarit.

2. Use the guide-piece to mark the position of the screws.

2. Con la ayuda de la plantilla, marcar la ubicación de los tornillos.

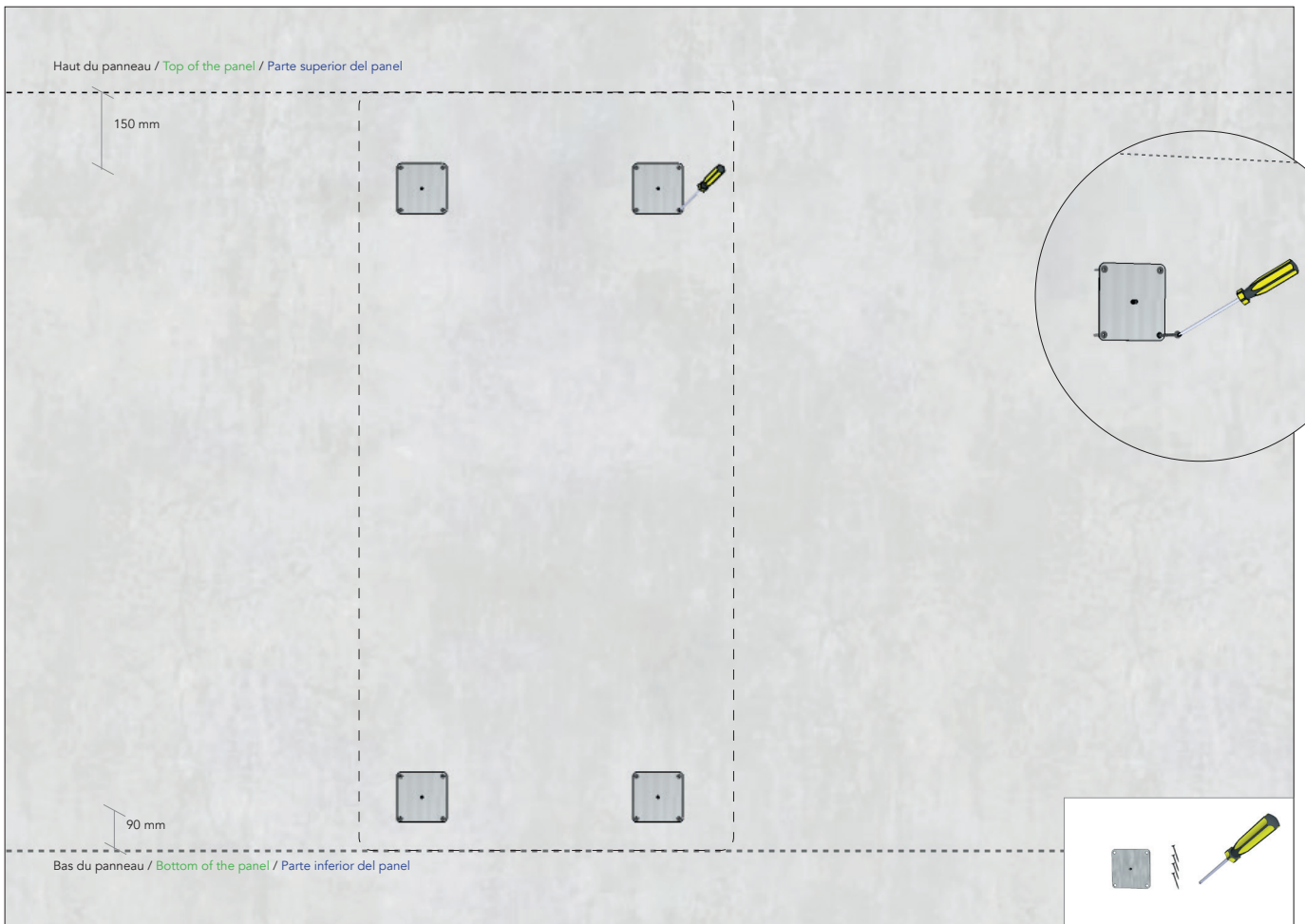

3. Installer les 4 patères.

3. Secure the 4 hooks.

3. Fijar las 4 pletinas.

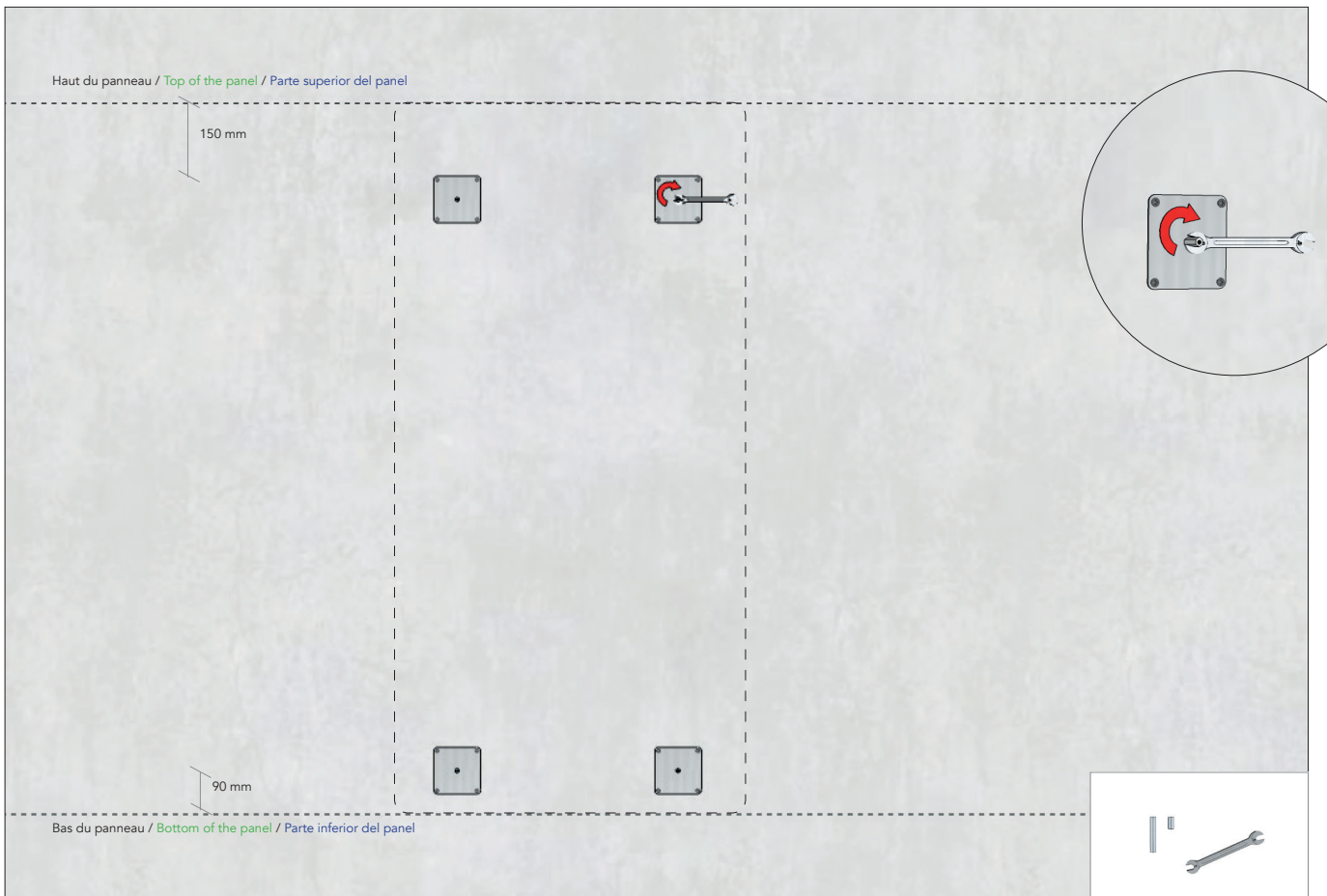

4. Installer les entretoises.

4. Secure the spacers.

4. Fijar los distanciadores

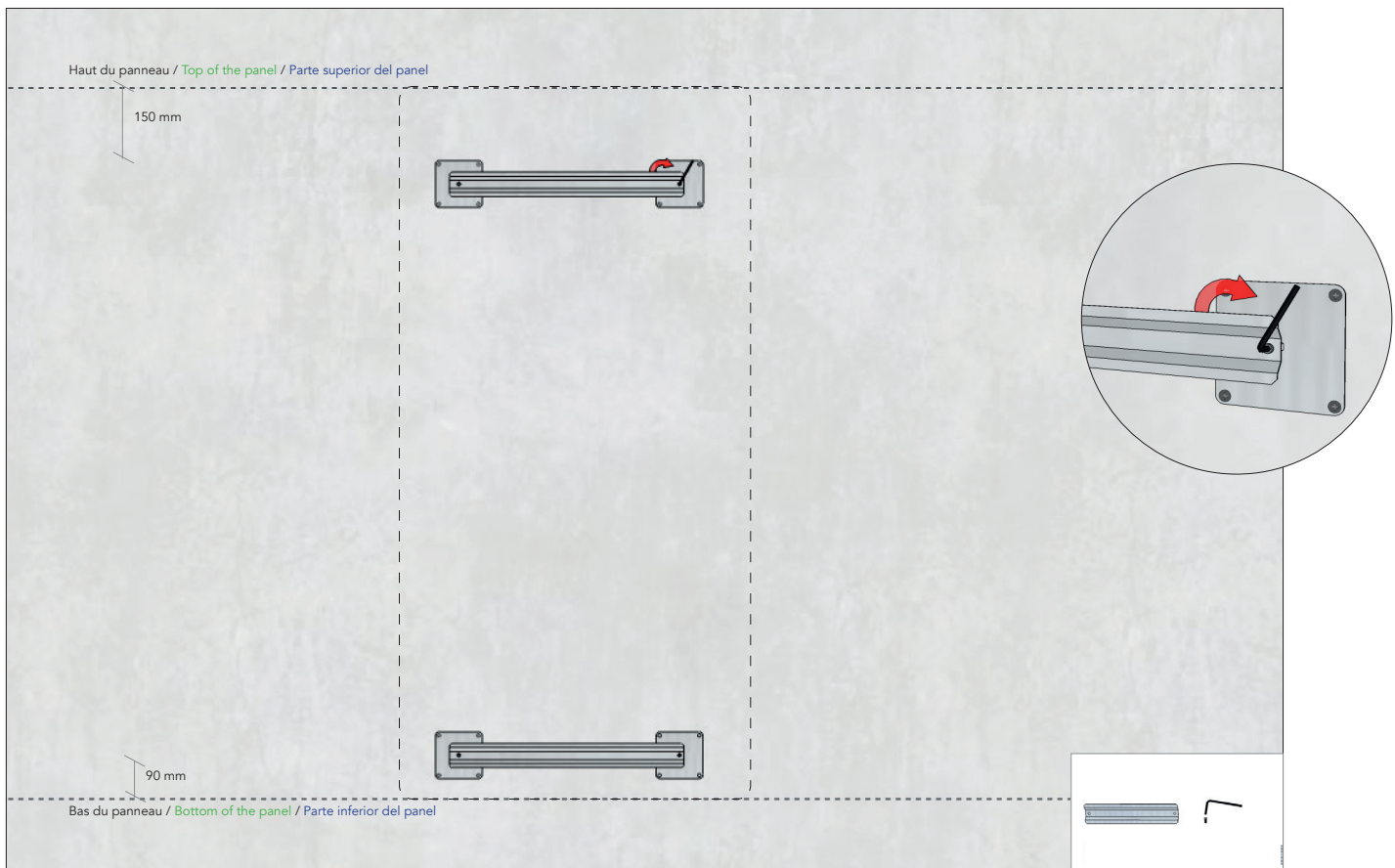

- 5. Fixer les rails avec les vis BTR.
- 5. Fasten the rails using socket-head screws
- 5. Fijar los rieles con tornillos allen

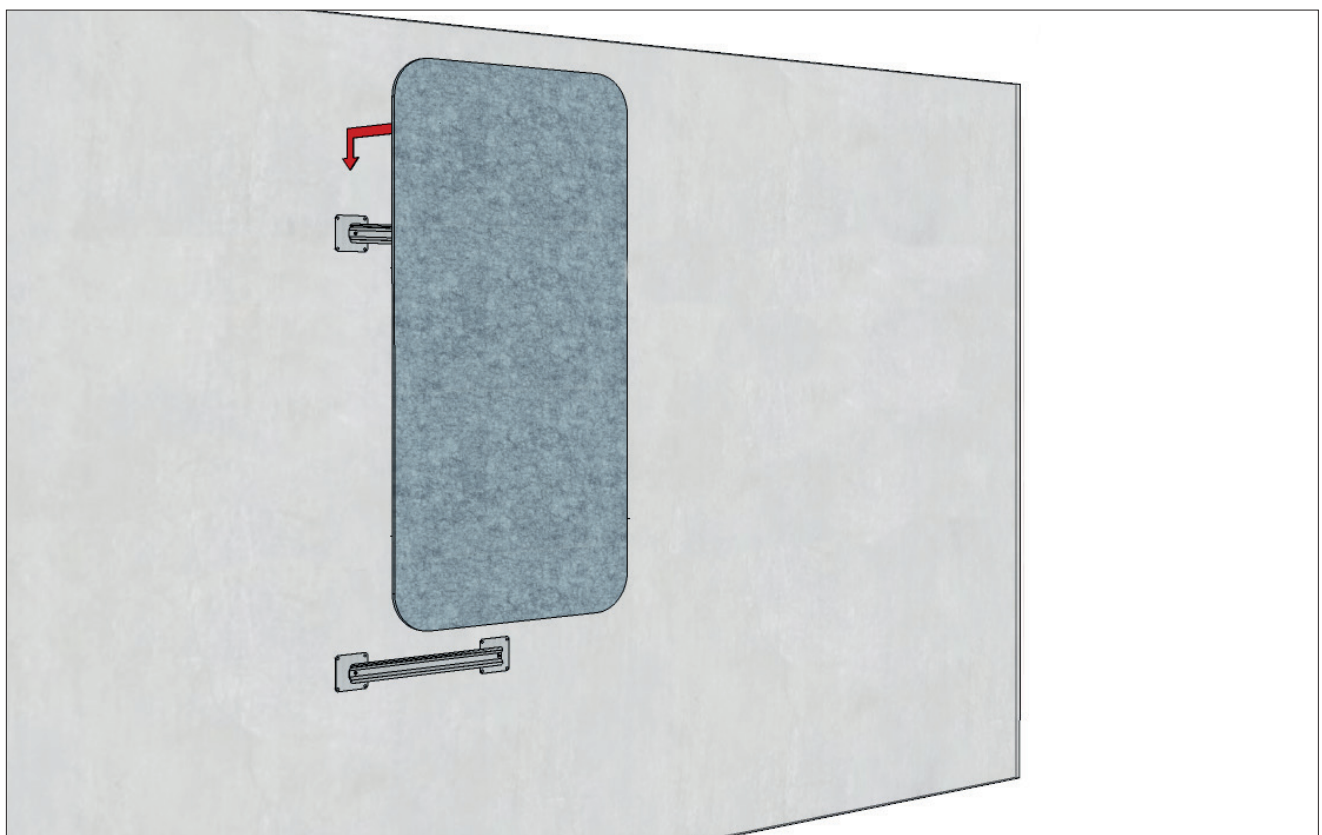

- 6. Installer le panneau
- 6. Mount the panel
- 6. Instalar el panel

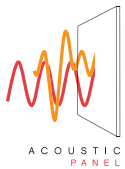

# SlimPanel

## Mural Rétro-Eclairé / Wall Backlit Mural con retroiluminación

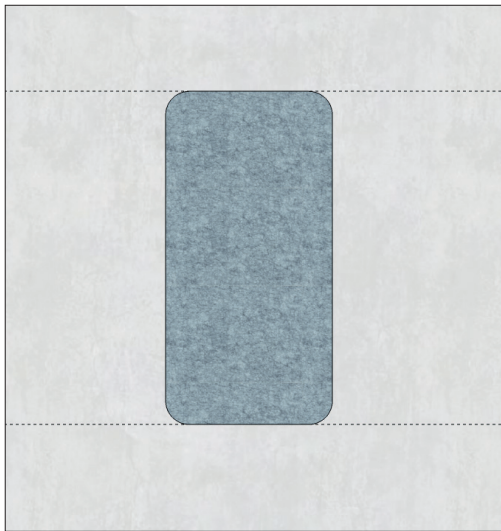

x1

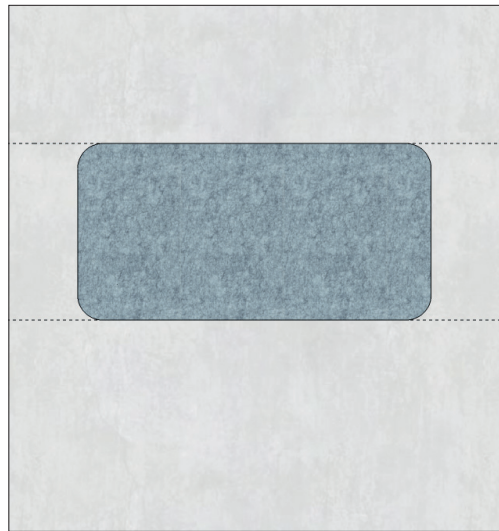

x1

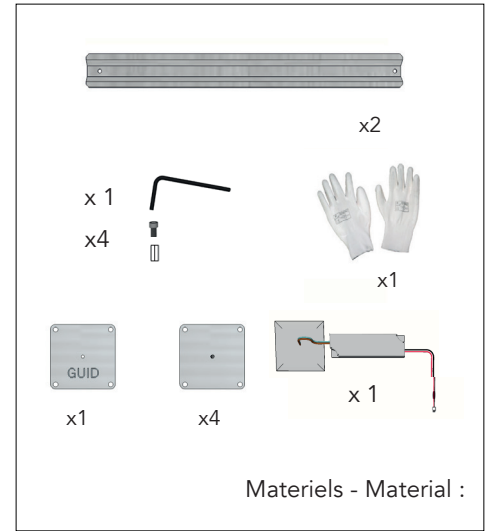

Materiels - Material :

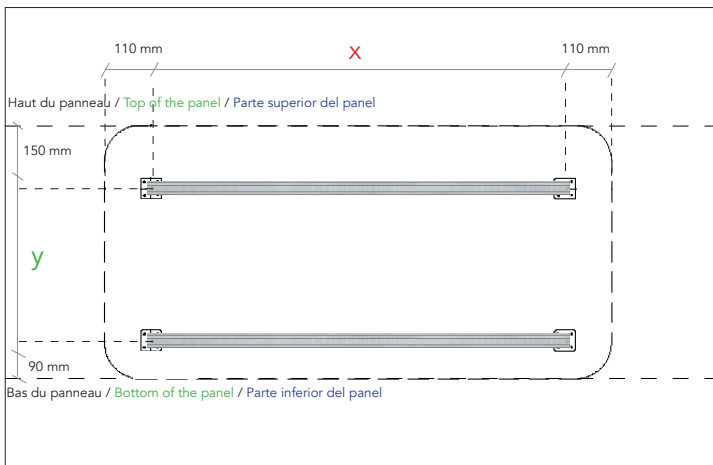

### Pose Horizontale ( en mm )

### Horizontal Mounting ( in mm )

### Posición horizontal ( en mm )

	x	y
1200 x 600	980 mm	360 mm
1200 x 400	980 mm	160 mm
2400 x 1200	2180 mm	960 mm
2400 x 600	2180 mm	360 mm
2400 x 400	2180 mm	160 mm

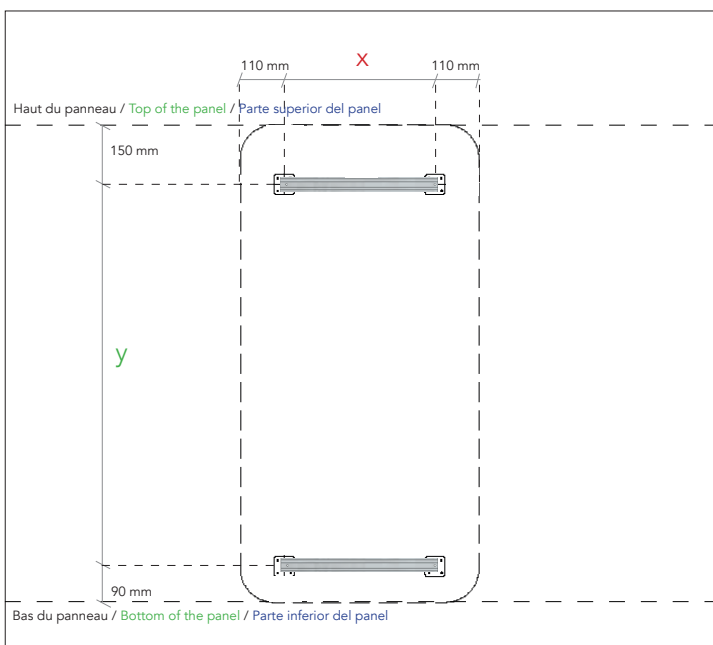

### Pose Verticale ( en mm )

### Vertical Mounting ( in mm )

### Posición vertical ( en mm )

	x	y
1200 x 1200	980 mm	960 mm
1200 x 600	380 mm	960 mm
1200 x 400	180 mm	960 mm
2400 x 1200	980 mm	2160 mm
2400 x 600	380 mm	2160 mm
2400 x 400	180 mm	2160 mm

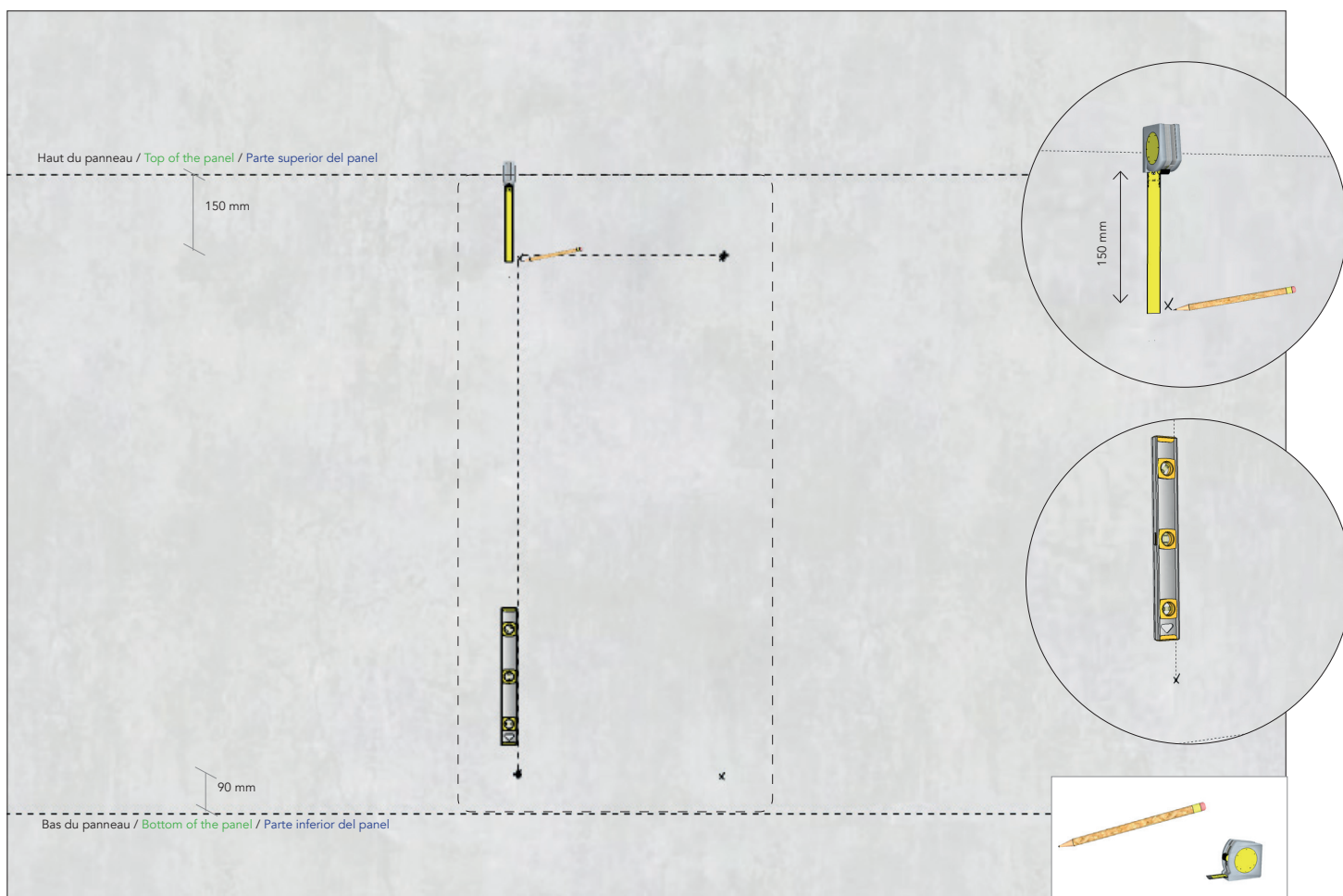

1. Définir l'emplacement du panneau final. Puis repérer les 4 patères, à l'aide du mètre, et du niveau, sur base du tableau au recto.

1. Decide the position of the final panel. Mark the 4 hooks.

1. Definir la ubicación final del panel. Marcar la ubicación de las 4 pletinas.

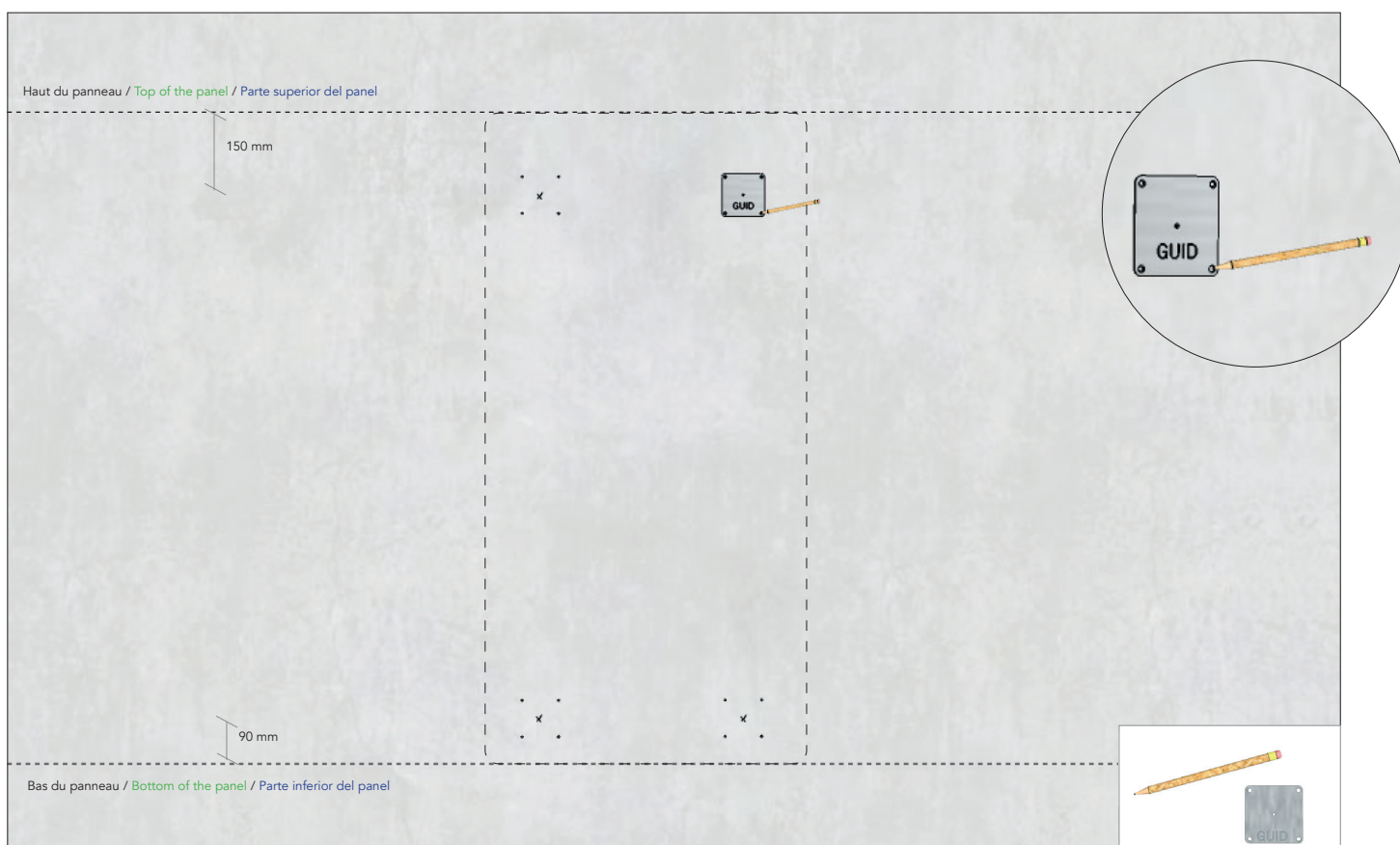

2. Marquer le placement des vis à l'aide du gabarit.

2. Mark the positions of the screws using the guide-piece.

2. Con la ayuda de la plantilla, marcar la ubicación de los tornillos.

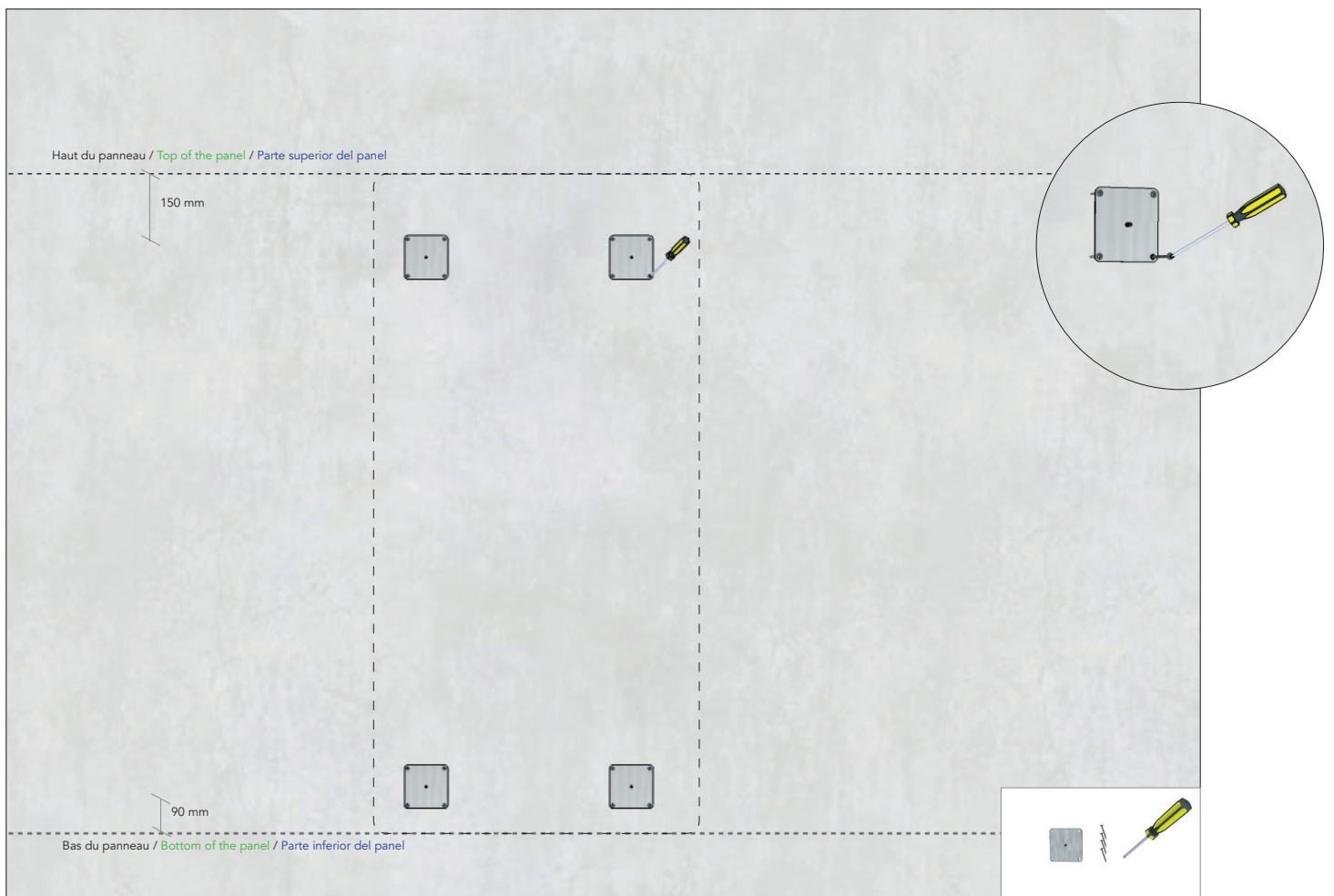

- 3. Installer les 4 patères.
- 3. Secure the 4 hooks.
- 3. Fijar las 4 pletinas.

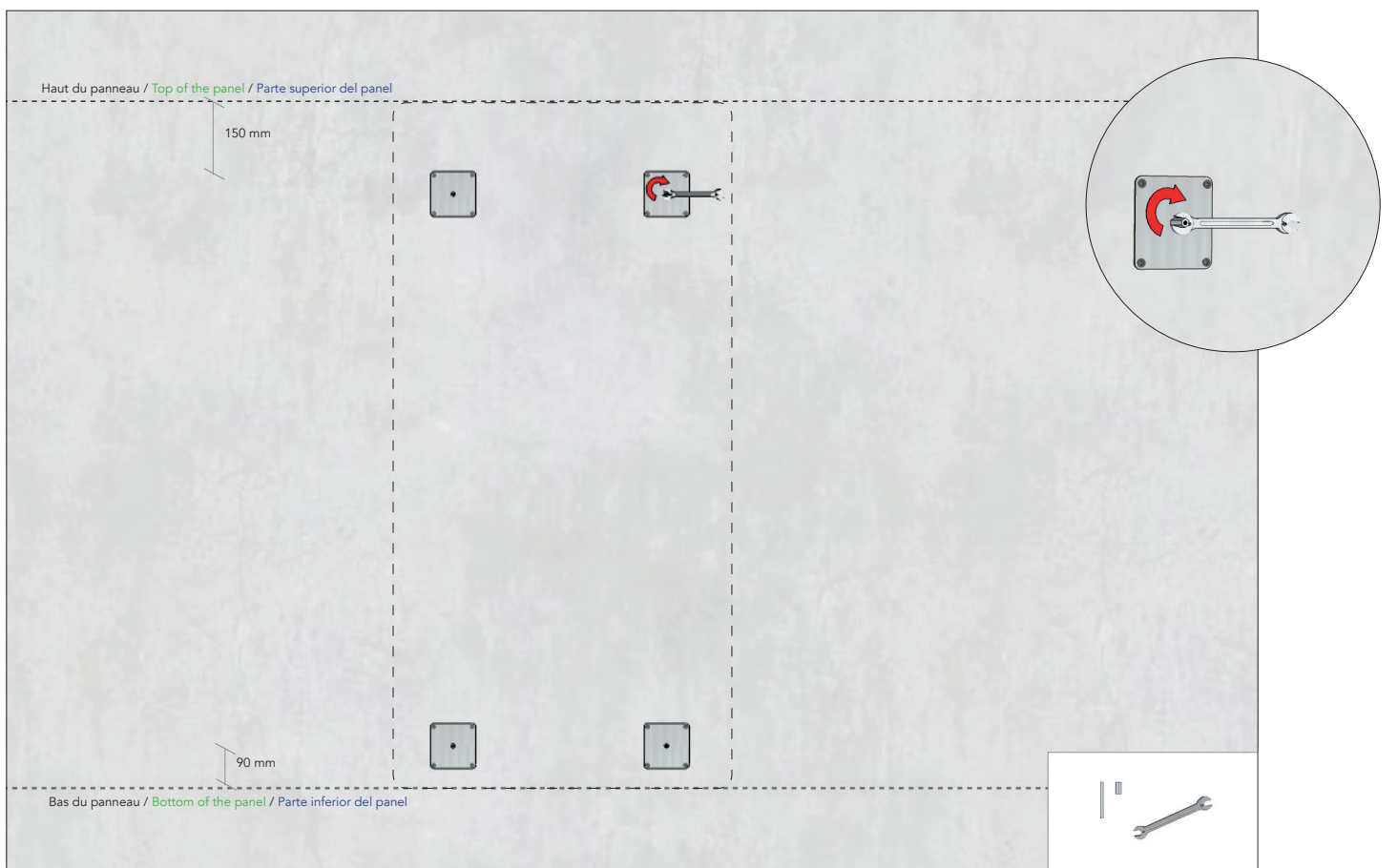

- 4. Installer les entretoises.
- 4. Secure the spacers.
- 4. Fijar los distanciadores.

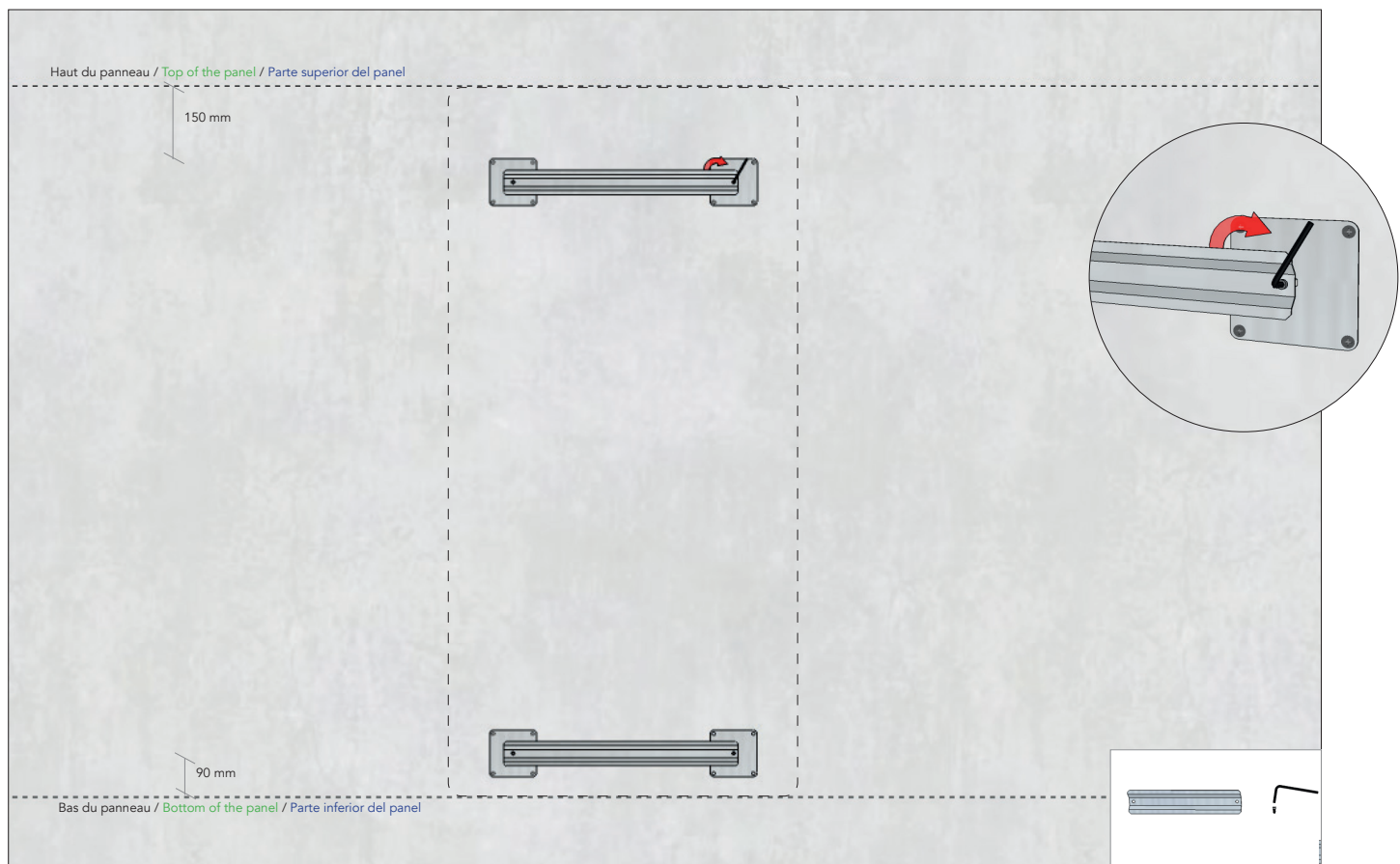

5. Fixer les rails avec les vis BTR.  
 5. Fasten the rails using socket-head screws.  
 5. Fijar los rieles con tornillos allen.

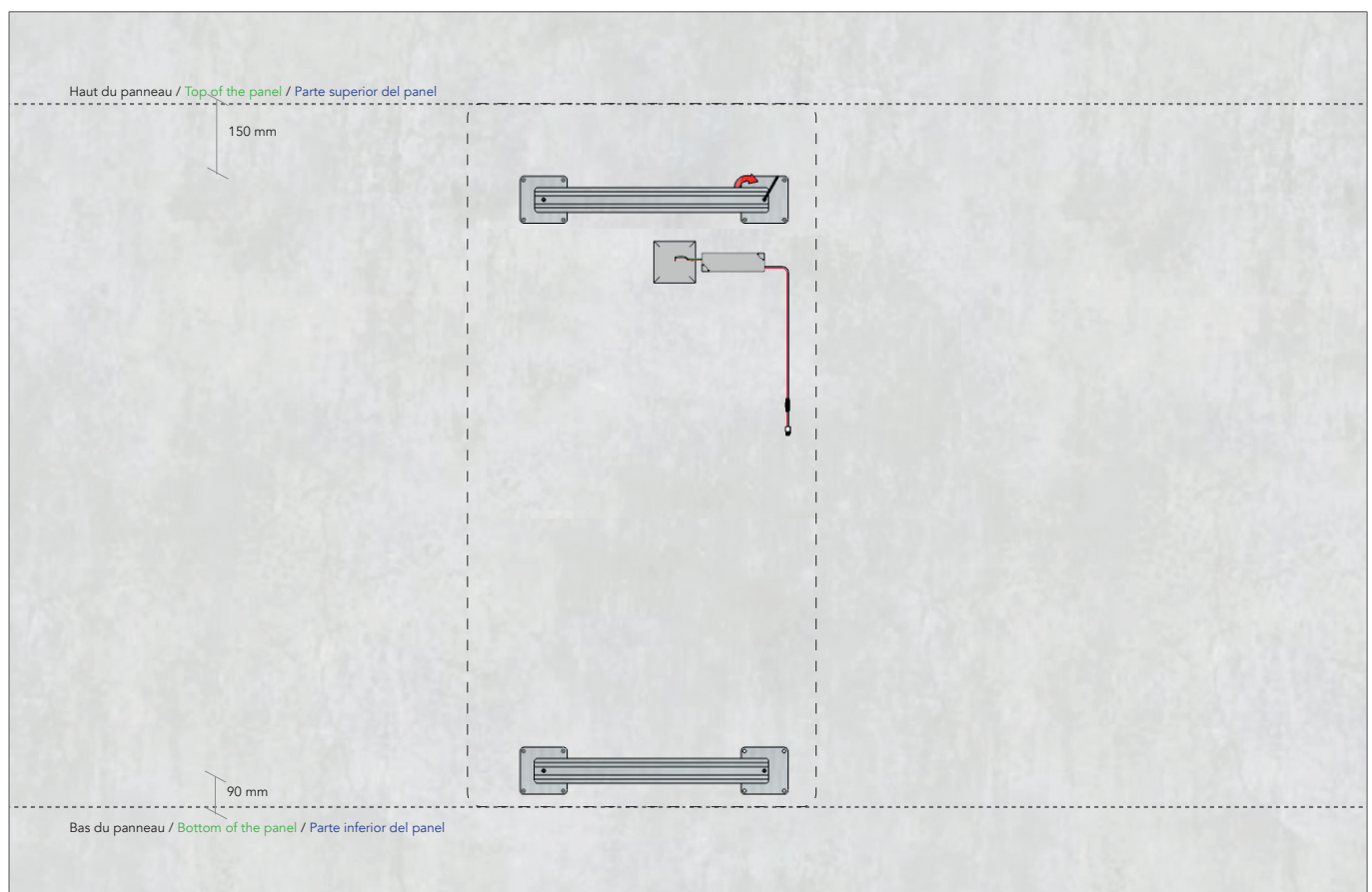

6. Installer le transformateur.  
 >11 cm à partir du bas du rail supérieur.  
 >2 cm à gauche de la patère supérieur droite.
6. Mount the transformer  
 >11 cm from the bottom of the upper rail.  
 >2 cm to the left of the top-right hook.
6. Colocar el transformador.  
 > a 11 cm debajo del riel superior.  
 > a 2 cm a la izquierda de la pletina superior derecha.



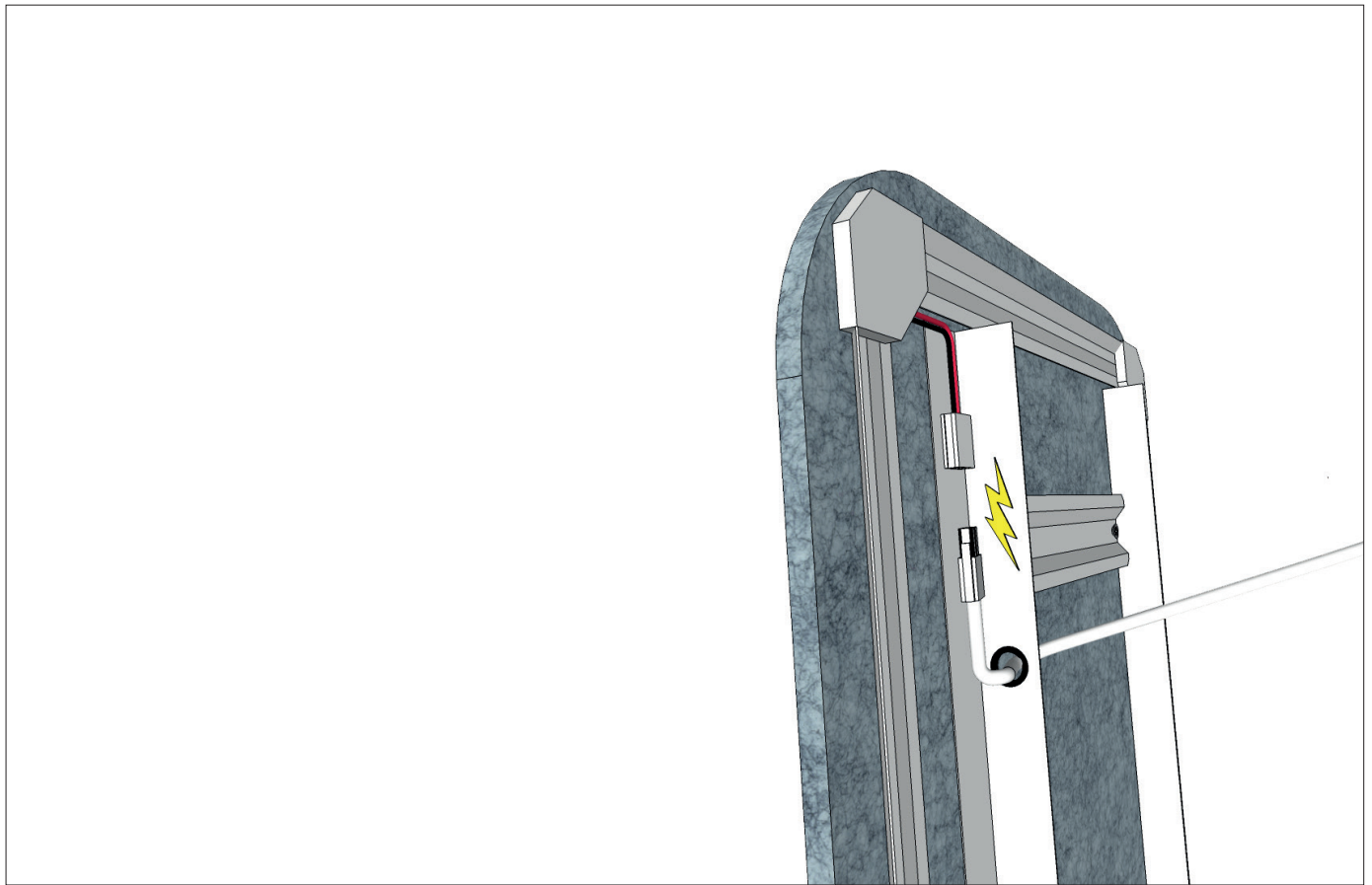

- 7. Connecter le panneau.
- 7. Connect the panel.
- 7. Conectar el panel.

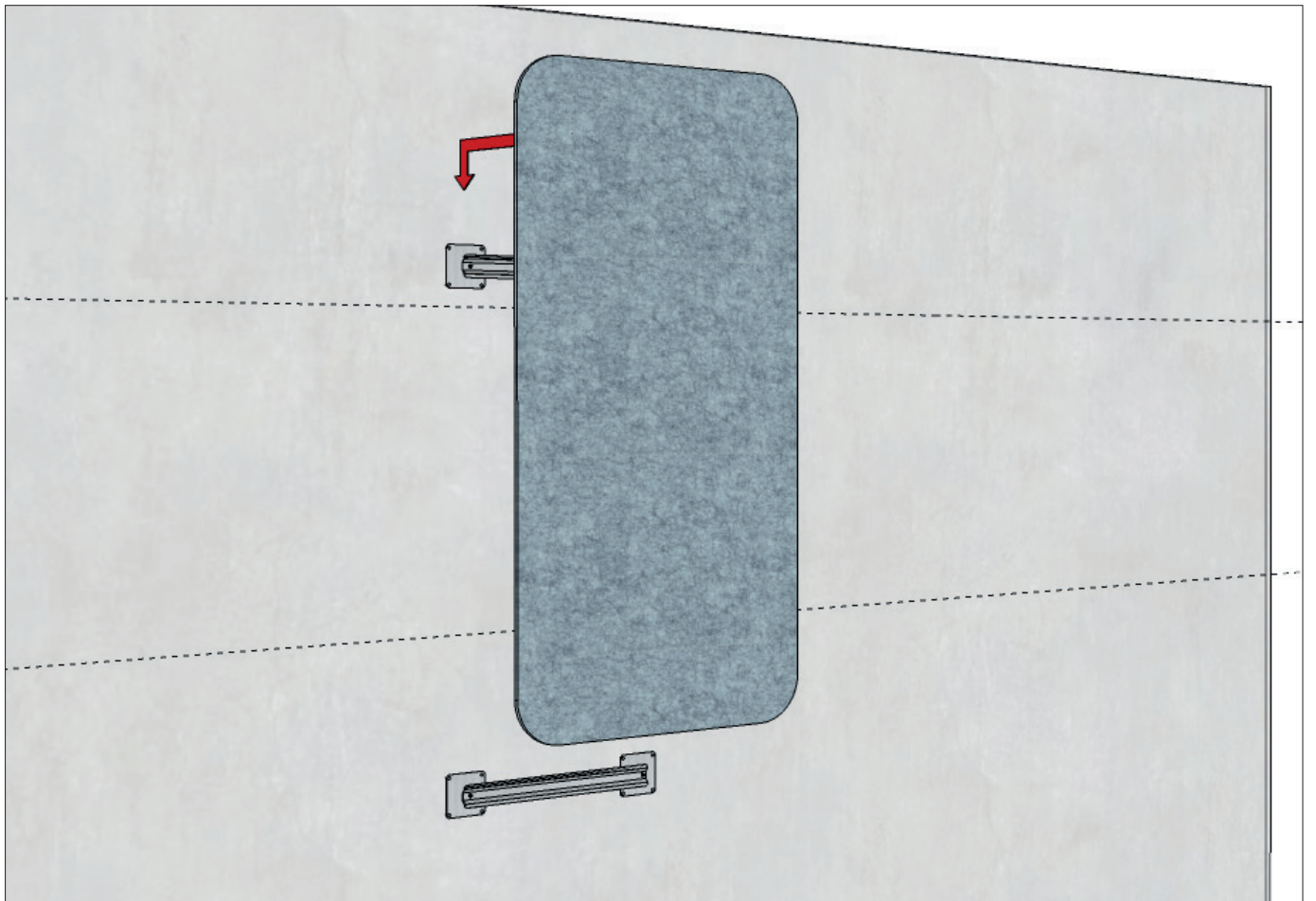

- 8. Installer le panneau.
- 8. Mount the panel.
- 8. Instalar el panel.